

F 015 746 031

Stand } 10-06-11
Issue }

Fig./Abb. 1

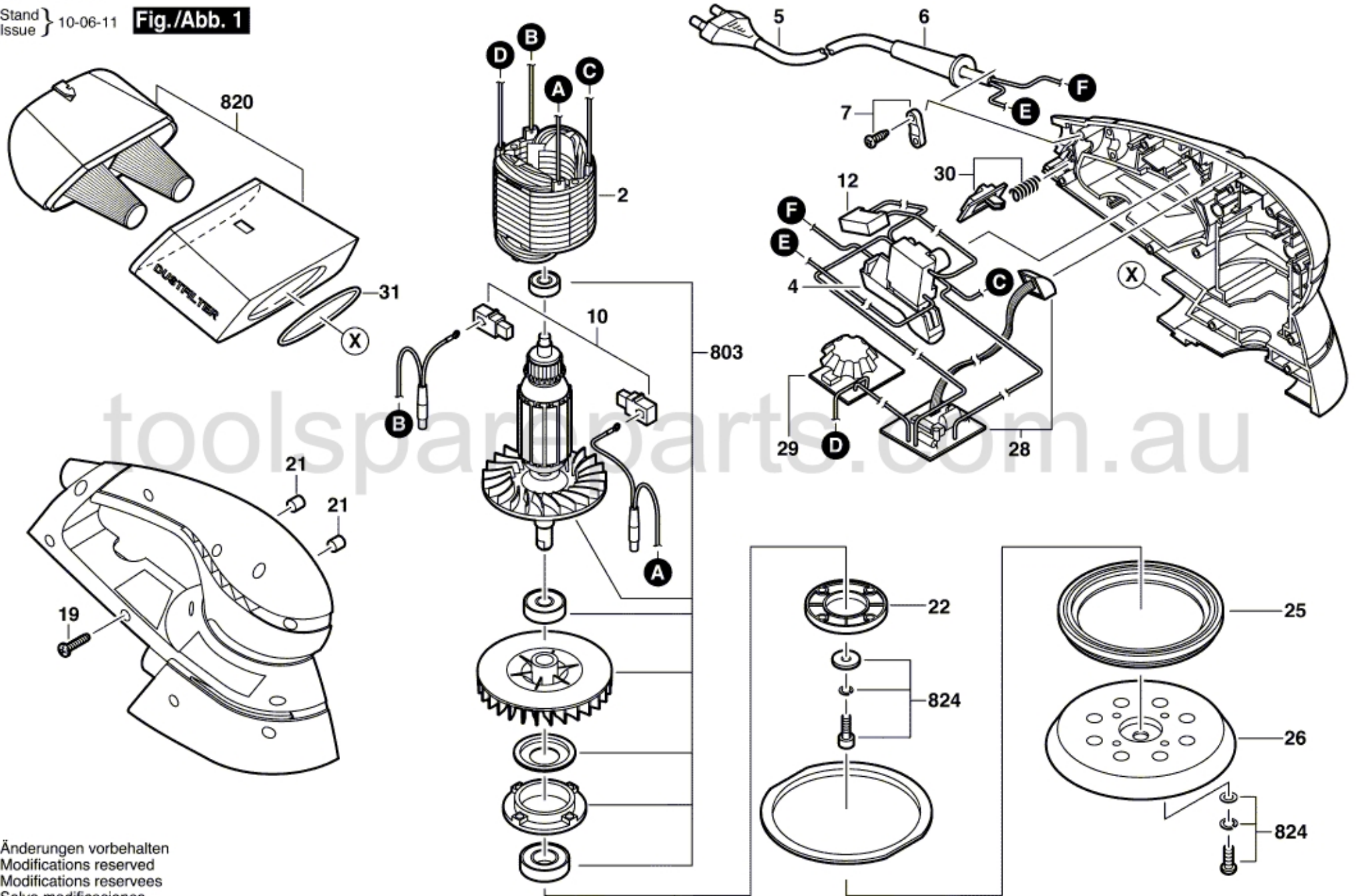

Änderungen vorbehalten
Modifications reserved
Modifications reserves
Salvo modificaciones